

## INTRODUCTION

Thank you for choosing the PT-2430PC. Your new P-touch labeler uses P-touch Editor Lite software, which is already installed on your labeler. There is no need to install any software or drivers onto your PC in order to make creative labels. This manual includes important precautionary information and simple instructions for operating your new P-touch labeler. Be sure to read the instructions before use and use the product in accordance with these instructions. Keep this manual handy for future reference.

## Federal Communications Commission (FCC) Declaration of Conformity (For USA Only)

Responsible Party: Brother International Corporation 100 Somerset Corporate Boulevard Bridgewater, NJ 08807-0911 USA  
TEL: (908) 704-1700

declares that the product: Product Name: P-touch Labeler PT-2430PC  
Model Number: PT-2430PC

This device complies with Part 15 of the FCC Rules. Operation is subject to the following two conditions: (1) this device may not cause harmful interference, and (2) this device must accept any interference received, including interference that may cause undesired operation.

This equipment has been tested and found to comply with the limits for a Class B digital device, pursuant to Part 15 of the FCC Rules. These limits are designed to provide reasonable protection against harmful interference in a residential installation. This equipment generates, uses and can radiate radio frequency energy and, if not installed and used in accordance with the instructions, may cause harmful interference to radio communications. However, there is no guarantee that interference will not occur in a particular installation. If this equipment does cause harmful interference to radio or television reception, which can be determined by turning the equipment off and on, the user is encouraged to try to correct the interference by one or more of the following measures:

- Reorient or relocate the receiving antenna.
- Increase the separation between the equipment and receiver.
- Connect the equipment into an outlet on a circuit different from that to which the receiver is connected.
- Consult the dealer or an experienced radio/TV technician for help.
- Changes or modifications not expressly approved by Brother Industries, Ltd. could void the user's authority to operate the equipment.
- The enclosed interface cable should be used in order to ensure compliance with the limits for a Class B digital device.

## SAFETY PRECAUTIONS

### WARNING

- Always use the specified voltage and the included AC adapter (AD-24ES) for this machine to prevent any damage or failure.
- Unplug the power cord immediately and stop using the P-touch labeler during an electrical storm. There may be a remote risk of electric shock from lightning.
- Do not use the AC adapter in places of high humidity such as bathrooms.
- Do not overload the power cord.
- Do not place heavy objects on, or damage the power cord or plug. Do not forcibly bend or pull the power cord. When disconnecting the power cord from the power outlet, always hold the plug.
- To prevent fire or electric shock, make sure that the plug is fully inserted to the power outlet. Do not use an outlet that is loose.
- Do not get the machine/AC adapter/power plug wet, such as by handling them with wet hands or spilling beverages on to them.
- Do not disassemble or modify P-touch labeler/AC adapter/batteries.
- Do not use metallic articles, such as tweezers or a metallic pen, when exchanging the batteries.
- Do not throw into fire or heat up the battery.
- Disconnect the AC adapter, remove batteries and stop using immediately if you notice any abnormal odor, heat, discoloration, deformation or anything unusual while in use, or in storage.

### CAUTION

- To avoid injuries, do not touch the blade of the cutter unit or any metal parts near the print head.
- Remove the batteries and disconnect the AC adapter if you do not intend to use P-touch labeler for an extended period of time.
- Do not use old and new batteries together or mix alkaline batteries with other type batteries, or set the positive and negative end in the wrong position. Otherwise, the batteries may leak or be damaged.
- To prevent damage or breakage, do not drop or hit P-touch labeler/AC adapter.
- Use only the USB cable included with the P-touch labeler.

### General Precautions

- Depending on the location, material, and environmental conditions, the label may unpeel or become irremovable, the color of the label may change or be transferred to other objects. Before applying the label, check the environmental condition and the material.
- Do not use the P-touch labeler in any way or for any purpose not described in this guide. Doing so may result in accidents or damage the machine.
- Use only Brother TZ tapes with this machine. Do not use tapes that do not have the  mark.
- Do not clean P-touch labeler with alcohol or other organic solvents. Only use a soft, dry cloth.
- Do not touch the print head with your fingers anytime to prevent from a burn. Use a soft wipe (e.g. a cotton swab) when cleaning the print head.
- Do not put any foreign objects into the tape exit slot or AC adapter connector, etc.
- Do not place the P-touch labeler/battery in direct sunlight or rain, near heaters or other hot appliances, in any location exposed to extremely high or low temperatures (e.g. on the dashboard or in the back of your car), high humidity, or dusty locations.
- Do not try to print labels using an empty tape cassette in the P-touch labeler. Doing so will damage the print head.
- Do not pull the tape being fed from the P-touch labeler, otherwise the tape cassette or P-touch labeler may be damaged.

## Getting Ready

### 1 Review the names of P-touch labeler parts.

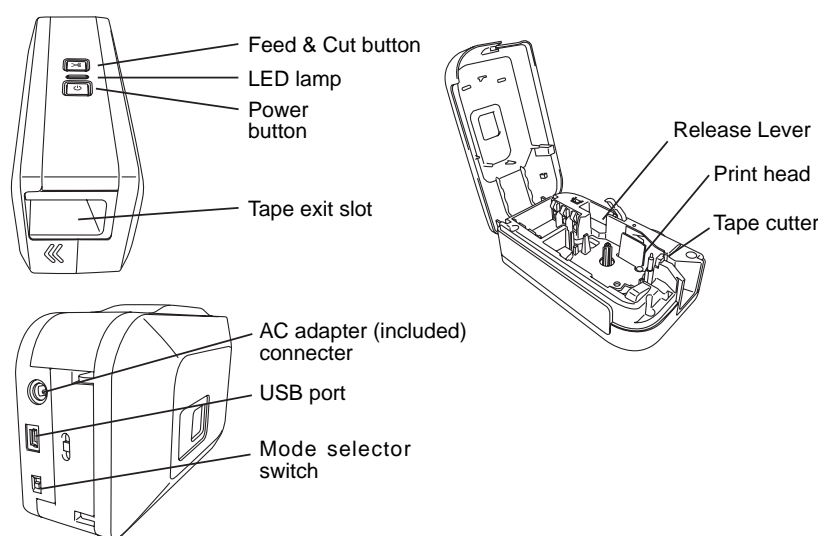

The PT-2430PC has 2 mode selector settings - "EL" and "E". The mode selector switch is pre-set at the factory to the EL mode, for use with P-touch Editor Lite. For E mode, you will need to install P-touch Editor 5.0, a more advanced labeling software, and the required drivers from the enclosed CD. For details on how to install the P-touch Editor 5.0, see "Starting P-touch Editor 5.0" below.

### 2 Install a tape cassette.

#### 1 Open the cassette cover.

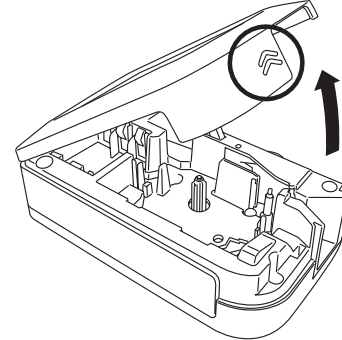

Verify that the P-touch labeler is turned off. Open the cassette cover as shown by the arrow in the above illustration while pressing the part marked "<<".

#### 2 Insert a tape cassette.

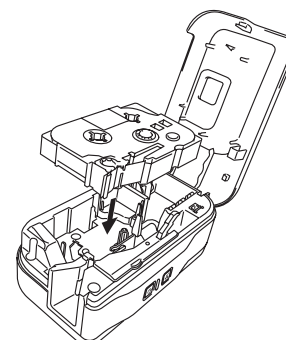

Insert a tape cassette as shown in the above illustration.

#### 3 Close the cassette cover.

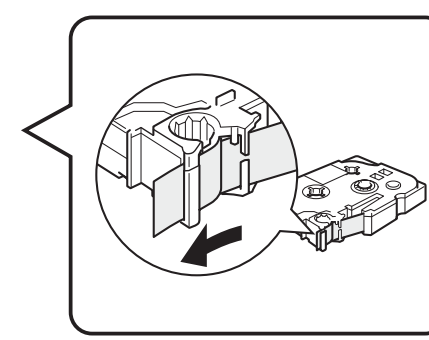

- Make sure that the end of the tape feeds under the tape guides.
- If the ink ribbon is loose, use your finger to wind the toothed wheel in the direction of the arrow on the cassette.
- Use only Brother tapes with the P-touch labeler.
- For initial use of the tape, install the tape. Then, push in the feed and cut button to cut the tape.
- Make sure that the release lever is up when closing the tape cover. The tape cover cannot be closed if the release lever is pressed down.

### 3 Connect the P-touch labeler's power supply.

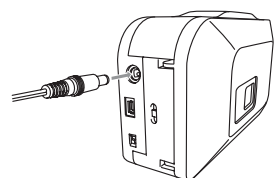

When using the included AC adapter (AD-24ES), insert the plug on the adapter cord into the adapter jack on the bottom end of the P-touch labeler. Insert the plug into the nearest standard electrical outlet.

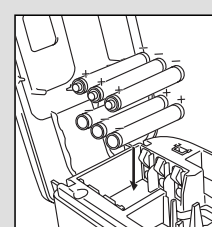

When using the P-touch labeler with batteries, insert six new AA alkaline batteries (LR6), making sure that their poles point in the correct directions. Always replace all six batteries at the same time using brand new ones.

### Auto Power Off Function

When the P-touch labeler is operating on battery power only, it will turn off automatically if not used for a period of 20 minutes. The message "Unsafe Removal of Device" may be displayed depending on the Operating System running on your PC. Any data being displayed will be saved. When you turn the labeler back on, click on the Editor Lite icon to resume creating your label.

### 4 Connect the USB cable and start P-touch Editor Lite.

#### 1 Connect the USB cable.

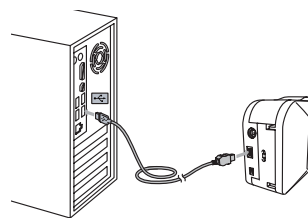

#### 2 Turn on the P-touch labeler. The LED lamp will light up.

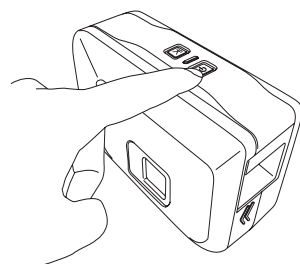

#### 3 Windows® 2000 User



Go to **My Computer** and open **Removable Disk**, then start P-touch Editor Lite by double-clicking **PTLITE10.EXE**.

#### 3 Windows® XP User



Pop-up Window Appears. Select **P-touch Editor Lite** and click **OK**.

#### 3 Windows Vista® User



Pop-up Window Appears. Click **P-touch Editor Lite**.

It will take longer than usual to start P-touch Editor Lite when connecting P-touch labeler to your computer for the first time. If the software does not start automatically when you connect the machine, you may launch it from **My Computer**. Start P-touch Editor Lite by double-clicking **PTLITE10.EXE**.

#### 4 P-touch Editor Lite starts immediately.



For details on using P-touch Editor Lite, see the back of this sheet.





Do not turn off the power or remove the labeler while using P-touch Editor Lite.

### Recommended When using Windows Vista®

When connecting the device for the first time, perform the scan and then select the **Always do this for software and games** check box on the dialog box displayed when the scan completes. P-touch Editor Lite will start automatically the next time you connect the P-touch labeler.

\*Microsoft Windows and Windows Vista are registered trademarks of Microsoft Corporation in the United States and other countries.  
\*The name of other software or products used in this document are trademarks or registered trademarks of the respective companies that developed them.

### How to disconnect the P-touch labeler

- Exit P-touch Editor Lite by clicking on the  at the top right.
  - To disconnect the labeler, click the icon in the computer's task bar (, , or ).
  - Click **Safely remove USB Mass Storage Device**.
- 
- When **The device can be safely removed** is displayed, turn off the P-touch labeler and disconnect the USB cable.

### Starting P-touch Editor 5.0

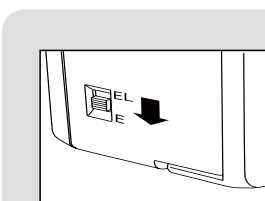

Move the mode selector switch on the back of the P-touch labeler to the "E" position before connecting the USB cable.

If you would like to use the more advanced software that is available for your P-touch labeler, you are able to install P-touch Editor 5.0 from the included CD-ROM. This advanced software will give you greater label making functionality.

**Do not connect the P-touch labeler to your PC before you begin the P-touch Editor 5.0 installation. For details on how to install P-touch Editor 5.0, see the installation guide in the included CD-ROM.**



## P-touch Editor Lite

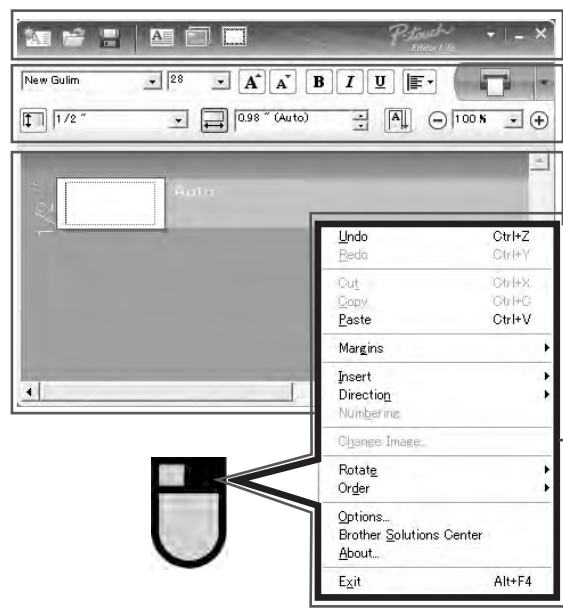

1  
2  
3  
4

### 1 Command Toolbar

| Icon | Function   |
|------|--|
|      | Displays the New screen for creating a new label.  |
|      | Opens a saved file with P-touch Editor Lite.   |
|      | Saves the data to your PC, etc, but not to the labeler.  |
|      | Inserts a new text box (convenient when creating labels containing both single and multiple lines of text).  |
|      | Inserts an image onto your label.<br><b>From file:</b> Inserts an image stored on your PC.<br><b>Screen capture:</b> Inserts the selected area of the PC screen as a graphic.<br><b>Symbol:</b> Inserts one of your PC's built-in symbols. |
|      | Inserts a frame.   |
|      | Displays the menu.<br>The menu includes all P-touch Editor Lite functionality.   |
|      | Minimizes P-touch Editor Lite.   |
|      | Exits P-touch Editor Lite.   |

### 2 Property Toolbar

| Icon | Function   |
|------|--|
|      | Click  to change the font.   |
|      | Click  to specify the font size.<br>You can adjust the font size up or down one level by clicking  or .  |
|      | Specifies the font style:<br><b>B</b> Bold <b>I</b> Italic <b>U</b> Underline  |
|      | Specifies the alignment of text in a text box.   |
|      | Sets the width of the tape. Click  to automatically detect the width of the inserted tape.   |
|      | Sets the length of the label. Click  to automatically adjust the length of the label to accommodate the entered text.  |
|      | Sets/cancels the label direction to vertical.  |
|      | Click  to set the zoom factor for the Label View.<br>You can also change the zoom factor by clicking  or .   |
|      | Click  to print normally or  to print with options.<br><b>Auto Cut:</b> Each label is automatically cut after printing.<br><b>Chain Printing:</b> The last label printed is not cut. After printing, press Feed & Cut button to cut the label.<br><b>Special Tape:</b> Select when you use a tape which cannot be cut with this cutter blade, such as Fabric Tape or Strong Adhesive tape etc.<br><b>Mirror Printing:</b> Prints a mirror image of the label.<br><b>Copies:</b> Prints multiple copies of a label. |

### 3 Label View

| Display | Function   | Display | Function   |
|---------|--|---------|--|
|         | This label view is displayed when the software is started. The width of tape currently set is displayed on the left of label image. When "Auto" is shown on the right, the length of tape is automatically adjusted to the length of text.   |         | Inserted text boxes, images, and frames are treated as objects. Objects are surrounded by handles (indicated by eight blue points).                        |
|         | You can drag the label border to manually change the length and width of the label. Move the pointer to the label area's border. When the blue line appears, drag to the desired length or width.  |         | Indicates that an object is selected.  |
|         | You can adjust the size of the P-touch Editor Lite window. Simply move the pointer over an edge of the P-touch Editor Lite window and drag to adjust the size once the pointer changes to an arrow.  |         | The pointer changes to an arrow when moved over a handle. You can change the size of the object by dragging.   |
|         | Guidelines are sometimes displayed when moving objects. They are shown when the object is aligned at the left, right, top, or bottom edge of Printable area, or in the center. In the illustration to the left, the guidelines indicate that the object is centered at the top edge of the tape. |         | You can move objects by dragging when the pointer is a crosshair. For text objects, the pointer only changes to a crosshair over the border of the object. |

### 4 Other Functions (available on the menu displayed by right-clicking the mouse)

| Menu                                      | Do this   |
|---|---|
| Undo<br>Redo                              | Click <b>Undo</b> to undo the last operation.<br>Click <b>Redo</b> to redo an undone operation.   |
| Cut<br>Copy<br>Paste                      | Select the text area (or object) that you want to cut or copy and select <b>Cut</b> or <b>Copy</b> . Click in the destination area and select <b>Paste</b> .  |
| Margins                                   | Set the length of blank space on both sides of the label ( <b>large</b> or <b>small</b> ).  |
| Insert                                    | Click <b>Insert</b> .<br>Select <b>Text box</b> to insert text onto the label.<br>Select <b>From File</b> to insert an image stored on your PC.<br>Select <b>Screen Capture</b> to insert the selected area of the PC screen.<br>Select <b>Symbol</b> to insert one of your PC's built-in symbols.<br>Select <b>Frame</b> to insert one of P-touch Editor Lite built-in frames. |
| Direction                                 | Select the object text and click either <b>Horizontal Text</b> or <b>Vertical Text</b> to change the direction of the label.  |
| Numbering                                 | Select the number or letter within your text and click <b>Numbering</b> to consecutively advance the number or letter on each label.  |
| Change Image                              | Select the image and click <b>Change Image</b> to replace the current image with a different image.   |
| Rotate                                    | Rotate objects to <b>0°, 90°, 180°</b> or <b>270°</b> .   |
| Order                                     | Select one of the objects and click <b>Order</b> , then select <b>Bring to Front</b> , <b>Send to Back</b> , <b>Bring Forward</b> , or <b>Send Backward</b> to set the order of each object in the layer.   |
| Options                                   | Click <b>Options</b> .<br>Select either <b>mm (mm)</b> or <b>inches (in)</b> to set the measurement unit setting and option for numbering printing.<br>Select either <b>Display New Value after Printing</b> or <b>Reset to Original Value after Printing</b> to set the numbering option.  |
| Brother Solutions Center<br>About<br>Exit | Click <b>Brother Solutions Center</b> to go to the web site for assistance and information.<br>Click <b>About</b> to learn about the P-touch Editor Lite version.<br>Click <b>Exit</b> to exit P-touch Editor Lite.   |

## Creating Labels

### Creating a mixed 1-row/2-row label containing a symbol

Annual Report Fiscal 2008  
Marketing Dept

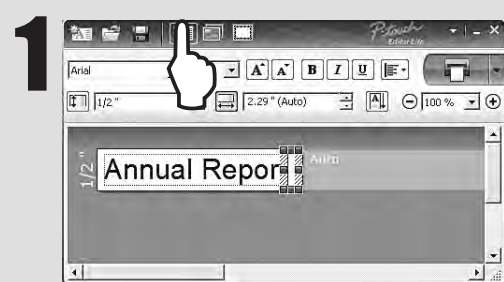

1 Select the tape size and enter the desired text. Insert a few spaces, then click the button.

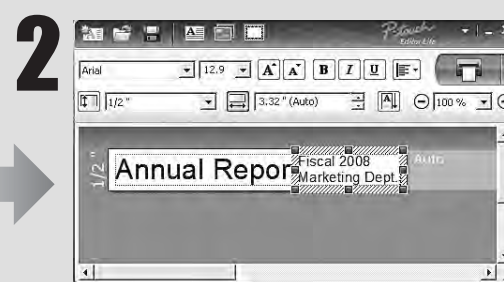

2 Enter the desired text and press the ENTER key. Enter the desired text on the second row.

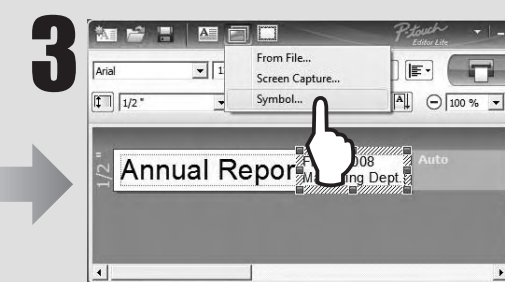

3 Click **Symbol** under . Select the symbol that you want to enter from the displayed dialog box.

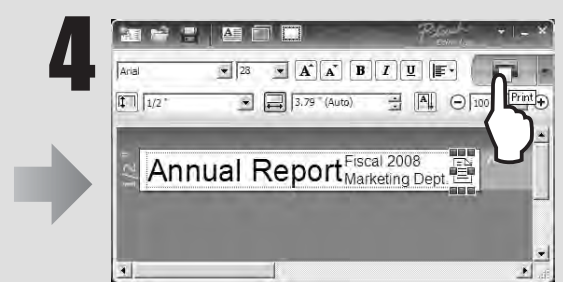

4 Click the **Print** button.

### Labels with consecutive numbering

Marketing Proposal File 1  
Marketing Proposal File 2

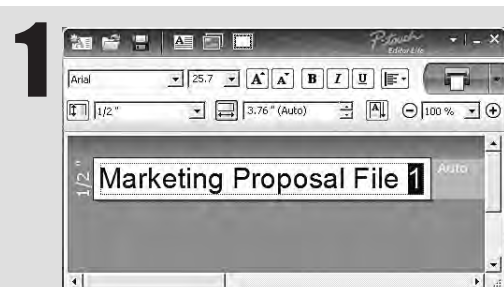

1 Select the tape size and enter the desired text. Select the text for which you want to configure numbering.



2 Click **Numbering** on the context menu.



3 Click to the right of the **Print** button and click **Print Options**.

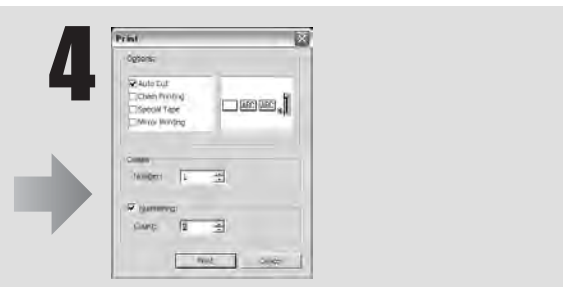

4 Check the **Numbering** box and enter the number of labels being printed in the **Count** field. Click the **Print** button.

### Troubleshooting

| Problem  | Solution  |
|--|---|
| After exiting P-touch Editor Lite, how do I restart the program while the machine is still on? | There are three ways to restart. Perform any of the followings.<br>• Turn off the P-touch labeler and then turn it back on.<br>• Disconnect and then reconnect the USB cable while the labeler is on.<br>• Launch P-touch Editor Lite from <b>My Computer</b> .   |
| The LED is flashing.   | This is an error message.<br>Please press the Feed & Cut button to clear the error message.<br>If the LED remains flashing after performing the above, please contact Brother Customer Service for further assistance.  |
| I cannot turn the P-touch labeler on.  | Check to see that the batteries are installed correctly, or that the recommended power adapter is securely connected.   |
| I cannot exit P-touch Editor Lite.   | Check to see if an error message is displayed, and try to resolve. Please note that the software cannot be exited while labels are being printed.   |
| A blank horizontal line appears through the printed label.                                     | Streaks or poor quality characters on printed labels generally indicate that the print head is dirty. Clean the print head using a cotton swab or optional print head cleaning cassette (TZ-CL4).<br>* Do not touch the print head directly with your bare hands. |
| The label is difficult to cut.   | Clean the cutter blade using a cotton swab moistened with alcohol.<br>* Do not touch the cutter blade directly with your bare hands.  |

Should you encounter any problems with your product, please do not return your product to the store!

After referring to the User's guide, if you still need assistance, call Brother Customer Service at:  
Voice: 1-877-4-PTOUCH Web: www.brother.com Fax: 1-901-379-1210

If you need to locate a service center, please call 1-800-284-HELP or visit us at www.brother.com

### Specifications

| Item         | Specification  |
|--------------|--|
| Dimension    | 2.6"(W)×7.4"(D)×4.4"(H)  |
| Weight       | 1.3lb (without batteries and tape cassette)                      |
| Power supply | Included AC adapter (AD-24ES) or six AA alkaline batteries (LR6) |
| USB port     | USB mini B type  |

### System Requirements PC

| Item             | Specification  |
|------------------|--|
| Operating System | Microsoft Windows® 2000 Professional/XP/Windows Vista® |
| System Memory    | 128MB minimum (Windows Vista - 512MB minimum)          |
| Interface        | USB Port (USB Spec. 1.1 or 2.0 protocol)               |
| Graphics Card    | SVGA   |

### Accessories (Supplies may differ by distribution)

| Accessories   | Stock No.   |
|---------------|---|
| Tape cassette | Brother TZ tape (width): 9/64", 1/4", 3/8", 1/2", 3/4", 1"<br>For details, see the included "Supplies and Accessories Guide". |
| AC Adapter    | AD-24ES   |